

VENTILEJAMĀS FASĀDES

Sortiments un Cenu katalogs

- Apšuvuma dēļi
- VL dēļi ar spundi
- Dekoratīvie paneļi
- Dizaina fasādes plāksnes
- Palīgmateriāli



WALLMORE

BŪVMATERIĀLU EKSPERTI



FASĀDES APŠUVUMA DĒĻU STRUKTŪRA UN IZSKATS

- + **Visdabiskākais izskats** pateicoties unikālajai dēļu struktūrai
- + Zemas apkopes izmaksas, pateicoties **Colur Plus krāsošanas tehnoloģijai**
- + Viegla montāža - **20% ātrāk**



pārklāts vertikāli (trīnītī)



pārklāts horizontāli (skujiņā)



vertikāla montāža



horizontāla montāža

FASĀDES APŠUVUMA DĒĻI

Hardie® Plank apšuvums piedāvā dabisku koka skaistumu, bet ir izgatavots no izturīga šķiedru cementa un neprasa apkopi.

Pieejami visi palīgmateriāli



Formāts mm			palete			krāsa	vienība kg	cena gabalā + pvn
garums	platums	biezums	gabali	m ^{2*}	ca. kg			
3600	180	8	84	54,4	622	standarta krāsa	7,4	14.85 18.56
						papildus krāsa		15.63 19.54

Cena gabalā + pvn
14.85 €
~~18.56~~ €

* 45.4 m² dēļu apšuvums ar 30 mm pārklājumu

** Minimālais apjoms 108,8m² par šo cenu. + 90EUR par nepilnu paleti. Projektiem pieejamas atlaides.

Hardie® Plank koka struktūras virsma

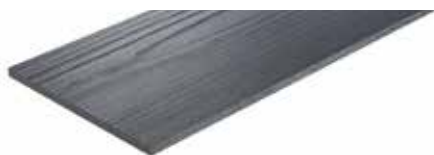

Hardie® Plank gluda virsma



standarta krāsa

krāsa	krāsas kods	Artikuls- nummurs	DB nummurs
Midnight Black	MB	5951220	1942387
Anthracite Grey	AY	5420122	1990851
Iron Grey	IG	5921220	1942386
Cobble Stone	CS	5751220	1942822
Light Mist	LM	5841220	1942385
Grey Slate	GS	5510122	1990855
Sail Cloth	SC	5691220	1942817
Arctic White	AW	5671220	1942383
Chestnut Brown	CB	5891220	1942832
Traditional Red	TR	5911220	1942819
Boothbay Blue	BB	5851220	1942829
Rich Espresso	RE	5460122	1990866
Pearl Grey	PG	5480122	1990865
Khaki Brown	KB	5711220	1942821

papildus krāsa ¹⁾

krāsa	krāsas kods	Artikuls- nummurs	DB nummurs
Midnight Black	MB	5921620	1942387
Grey Slate	GS	5510162	1990868
Anthracite Grey	AY	5420122	1990851
Soft Green	SG	5811620	1943073
Iron Grey	IG	5951620	1943063
Cobble Stone	CS	5751620	1943067
Light Mist	LM	5841620	1943062
Arctic White	AW	5670162	1943060
Boothbay Blue	BB	5851620	1943075

¹⁾ Piegādes laiks apmēram 8 nedēļas

papildus krāsa ¹⁾

krāsa	krāsas kods	Artikuls- nummurs	DB nummurs
Evening Blue	EB	5861220	1942830
Mountain Sage	MS	5801220	1942826
Heathered Moss	HM	5791220	1942825
Monterey Taupe	MT	5761220	1942823
Soft Green	SG	5811220	1943073
Woodland Cream	WC	5681220	1942827
Timber Bark	TB	5771220	1942824

¹⁾ Piegādes laiks apmēram 8 nedēļas

FASĀDES VL DĒĻI AR SPUNDI

Fasādēm ir svarīgi sasniegt visaugstākos arhitektūras standartus un vienlaikus nodrošināt vienkāršu uzstādīšanu. Uzstādīšanas laikā dēļu stiprinājumi ir pilnībā paslēpti, pateicoties inovatīvai rievu un gropju sistēmai, tādējādi ietaupot montāžas laiku un izmaksas.



Formāts mm			Paleta	Paleta	Svars	Sedzamais	cena sākot no	
garums	platums	biezums	gabali	m ²	vienam dēlim	laukums m ²	Eur/m ² + pvn	
3600	214	11	160	123,2	1765	10,5	104,8	43,48

Minimālais apjoms
123,2m par šo cenu
+ 90 EUR par nepilnu paleti
Projektam pieejamas atlaides.

Hardie® Plank dekoratīvais VL dēlis ar spundi

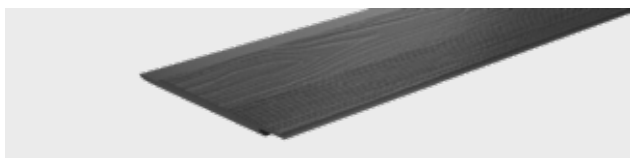

standarta krāsa

krāsa	krāsas kods	Artikuls- nummurs	DB nummurs	
	Midnight Black	MB	5952121	1942387
	Anthracite Grey	AY	5422121	1990851
	Sail Cloth	SC	5692121	1942817
	Arctic White	AW	5672121	1942383
	Light Mist	LM	5842121	1942385
	Grey Slate	GS	5512121	1990855
	Chestnut Brown	CB	5892121	1942832
	Khaki Brown	KB	5712121	1942821

¹⁾ Piegādes laiks apmēram 8 nedēļas

Pieejami visi palīgmateriāli



FASĀDES APŠUVUMA PANELIS

Ar Hardie® Panel fasādes apšuvumu ikviena mājas fasāde iegūst nevainojamu izskatu. Šķiedras cementa paneli ir izturīgi, droši un ar mazu apkopes nepieciešamību.

Pieejami visi palīgmateriāli



garums	Formāts mm		paletes gabali	m ²	ca. kg	krāsa	vienība kg	cena Eur/m ² + pvn
	platums	biezums						
3048	1220	8 un 11	25	93	1043	standarta krāsa	41,7	PĒC PIEPRAŠĪJUMA

Projektam pieejamas atlaides!

Hardie® Panel gluda virsma



standarta krāsa

krāsa	krāsas kods	Artikulu- nummurs	DB nummurs
	AY	5421352	1990875
	IG	5923521	1943031
	GS	5511352	1990876
	AW	5673521	1943028
	MB	5952121	1942387
	CS	5751620	1943067
	LM	5841620	1943062



HardiePanel® pieejama jebkura krāsa, 6 nedēļu laikā, pasūtot 2 pilnas paletes

HardiePanel® ar gludo virsmu ir vidēja blīvuma šķiedras cementa panelis izmantošanai fasādei. Tas nav ne nepartraukti krāsots, ne sablīvēts, ne slīpēts. Tāpēc optiski/vizuāli pārkāpumi var parādīties uz paneļiem strīpu, viļņu vai tekstūras veidā. Šie pārkāpumi neietekmē produkta vispārējās īpašības un vizuāli izskatās dabiski. Tāpēc garantija uz vizuālajiem efektiem neattiecas.

DIZAINA PLĀKSNE FASĀDEI

Gudrs, rentabls risinājums ikvienam projektam, kas nodrošina stilu, kvalitāti un aizsardzību par nepārspējamu cenu.

Pieejami visi palīgmateriāli



garums	Formāts mm		paletes gabali	m ²	ca. kg	krāsa	vienība kg	cena Eur/m ² + pvn
	platums	biezums						
3048	1220	8	25	93	1043	standarta krāsa	41,7	PĒC PIEPRASĪJUMA

Projektam pieejamas atlaides!

Gluda smilšu strūkla



Matēta betona struktūra



Matēta betona krāsa

krāsa	krāsas kods	Artikuls- nummurs	DB nummurs	
	Anthracite Grey	AY	5429362	1990875
	Cobble Stone	CS	5759362	1943037
	Grey Slate	GS	5519362	1990876
	Arctic White	AW	5679362	1943028
	Light Mist	LM	5849362	1943030
	Midnight Black	MB	5959362	1942494

Gluda smilšu strūklas krāsa

krāsa	krāsas kods	Artikuls- nummurs	DB nummurs	
	Anthracite Grey	AY	5429352	1990875
	Cobble Stone	CS	5759352	1943037
	Grey Slate	GS	5519352	1990876
	Arctic White	AW	5679352	1943028
	Light Mist	LM	5849352	1943030
	Midnight Black	MB	5959352	1942494



METĀLISKA IZSKATA DIZAINA PLĀKSNE FASĀDEI

Unikāla šķiedru cementa tekstūra ar metālisku efektu. Dzirkstošie pigmenti un unikālā struktūra rada neatkārtojamu izskatu, kas mainās dabiskā apgaismojumā.

Pieejami visi palīgmateriāli



garums	Formāts mm		paletes gabali	m ²	ca. kg	krāsa	vienība kg	cena Eur/m ² + pvn
	platums	biezums						
3048	1220	8	25	93	1043	standarta krāsa	41,7	PĒC PIEPRAŠĪJUMA

Projektam pieejamas atlaides!

Gold



Bronze



Copper



Gun Metal



Silver



Steel



Pieejamās krāsas





















krāsa		Paneļu artikuls	Color Plus artikuls
	Gold	5555382	5300107
	Bronze	5557382	5300105
	Copper	5559382	5300106
	Gun Metal	5558382	5300102
	Silver	5556382	5300104
	Steel	5560382	5300103

COLOUR PLUS™ AKRILA KRĀSA

Akrila krāsa pieskaņota tieši James Hardie™ ColourPlus™ krāsa nepieciešama priekš griestajām malām, pēc fasādes apdares plākšņu griešanas. Kā arī priekš maziem labojumiem.



Daudzums L	Bundžas/ Kastes	Pārklājums	Cena gb.
0,5	11	10m ² uz L	36,00

Krāsa	Krāsas kods	Artikula nummurs	DB nummurs
 Arctic White	AW	5300148	1942490
 Cobble Stone	CS	5300132	1990887
 Sail Cloth	SC	5300144	1990884
 Woodland Cream	WC	5300150	1990885
 Soft Green	SG	5300145	1990893
 Light Mist	LM	5300138	1942492
 Pearl Grey	PG	5300424	1990881
 Monterey Taupe	MT	5300139	1990888
 Khaki Brown	KB	5300137	1990886
 Heathered Moss	HM	5300135	1990891
 Mountain Sage	MS	5300140	1990892
 Boothbay Blue	BB	5300130	1990894
 Evening Blue	EB	5300134	1990895
 Grey Slate	GS	5300425	1990880
 Chestnut Brown	CB	5300131	1990896
 Traditional Red	TR	5300147	1990883
 Timber Bark	TB	5300146	1990889
 Midnight Black	MB	5300149	1942494
 Anthracite Grey	AY	5300423	1990879
 Iron Grey	IG	5300136	1942493
 Rich Espresso	RE	5300426	1990882

* James Hardie krāsu palete apskatāma kataloga beigās

Krāsa		Fasādes dēļi		VL dēļi	Paneļi	Arhitektūras Paneļi
Krāsu nosaukums	Krāsu kods	Struktūra	Gluds	Struktūra	Gluds	
Arctic White	9003					
Sail Cloth	1013					
Light Mist	7035					
Grey Slate	7042					
Khaki Brown	1019					
Chestnut Brown	8025					
Anthracite Grey	7016					
Midnight Black	9004					
Cobble Stone	7044					
Boothbay Blue	7000					
Iron Grey	7043					
Woodland Cream	1015					
Soft Green	7032					
Monterey Taupe	7002					
Montain Sage	6013					
Pear Grey	7047					
Heathered Moss	1020					
Evening Blue	7011					
Traditional Red	3009					
Timber Bark	7006					
Rich Espresso	7022					

*Krāsas attēlojums var būt nedaudz atšķirīgs, tas var atšķirties no ekrāna vai printējuma kvalitātes

MONTĀŽAS PIEDERUMI

Ārējā stūra profils

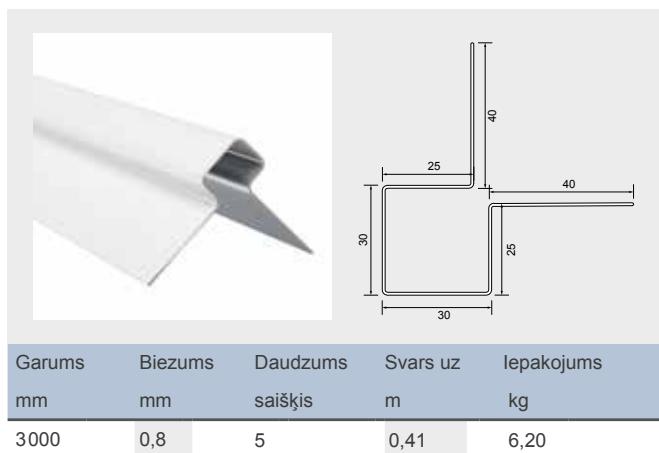

Iekšējā stūra profils

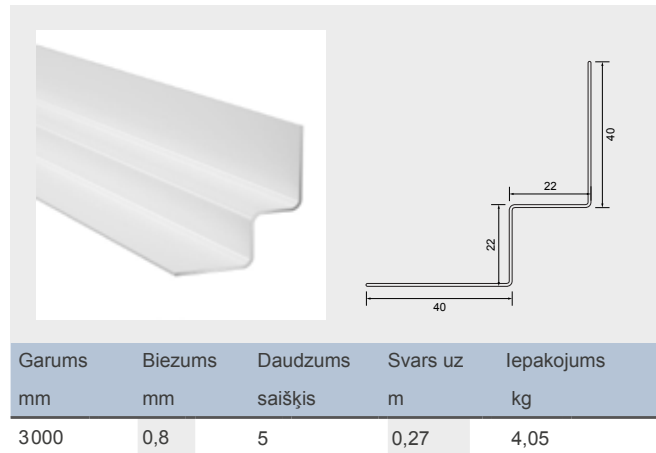

Palodze

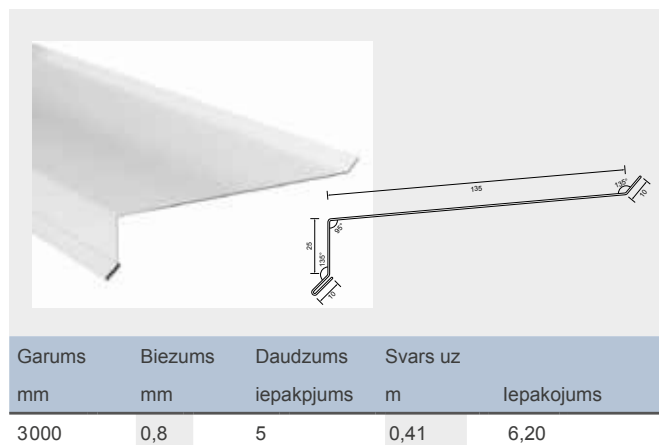

Pārsegs

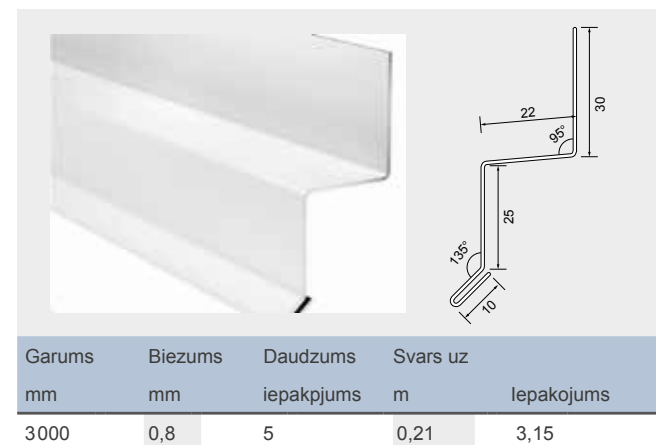

Beigu profils

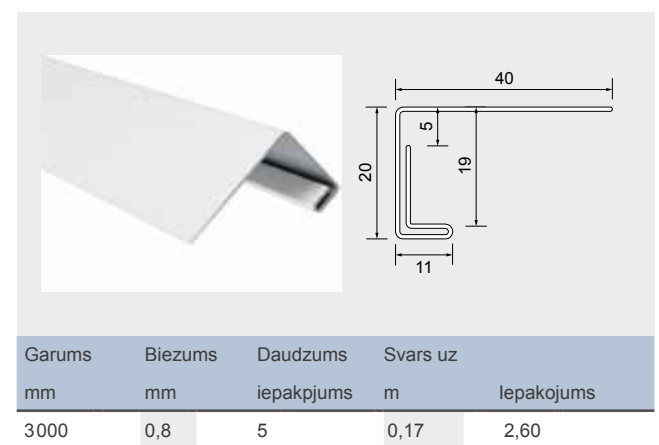

Horizontāla klājuma profils

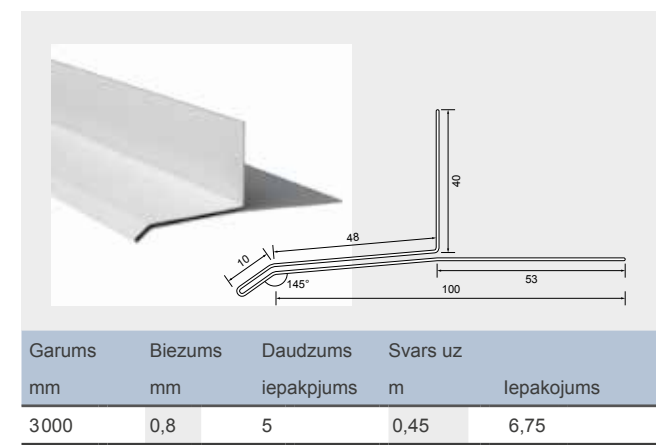

MONTĀŽAS PIEDERUMI

Vertikāla klājuma profils

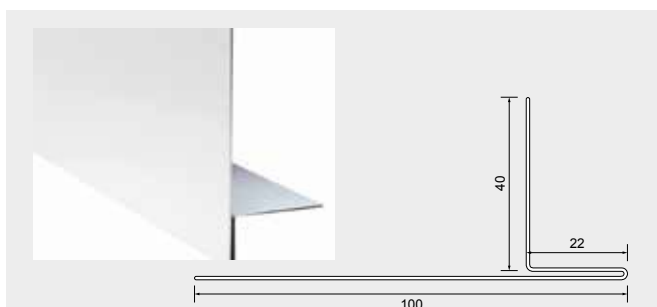

Garums mm	Biezums mm	Daudzums iepakojums	Svars uz m	Svars uz iepakojums
3000	0,8	5	0,35	5,25

Fasādes skrūves (4,8x39)



Fasādes skrūves ir krāsu atbilstošas mūsu ColourPlus™ produktiem, lai tās izskatītos pēc iespējas neitrālāk.

JamesHardie® fasādes skrūves 4.8 × 30 mm - Nerūsējošas A2 - orx 20 (Nepieciešama iepriekšēja urbšana)

Izmēri mm ø × garums	Gab,	Patēriņš uz m ² c/c 400 mm	c/c 600 mm	Krāsa
4,8x39	250	19 gab.	13 gab.	<u>standarta krāsa</u> papildus krāsa

Celtniecības skrūves ar urbšanas galu un spārnu (4,8x39)

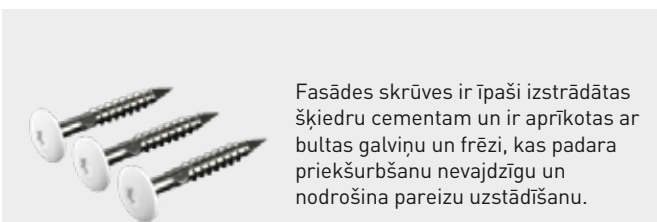

Fasādes skrūves ir īpaši izstrādātas šķiedru cementam un ir aprīkotas ar bultas galviņu un frēzi, kas padara priekšurbšanu nevajadzīgu un nodrošina pareizu uzstādīšanu.

JamesHardie® fasādes skrūves 4.8 × 38 mm - Nerūsējošas A2 - orx 20 (Nepieciešama iepriekšēja urbšana)

Izmēri mm ø × garums	Gab,	Patēriņš uz m ² c/c 400 mm	c/c 600 mm	Krāsa
4,8x38	75** 250	19 gab.	13 gab.	<u>standarta krāsa</u> standarta krāsa papildus krāsa

**nav pieejams papildus krāsās skrūvēm

EPDM Lente



UV-izturīga lente, kas paredzēta, lai pārsegtu un aizsargātu šuvi starp plāksnēm.

Izmērs	Iepakojuma izmērs		
Garums m	Platums mm	Biezums mm	
20	60 100	0,75	Biezums: 0.7 mm. 10 rullī kastē, melni

HardieGuillotine™ giljotīne



Pielāgots rokas instruments ātri un precīzi izgriež fasādes dēļus un garantē, ka tie ir izturīgi pret pārrāvumiem, plaisām un putekļiem

Vienība

1 vienība

HardieBlade™



Speciāli izstrādāts disks putekļu samazināšanai. Piemērots lielākajai daļai tirgū pieejamo elektrisko ripzāģu

Izmērs mm	Vienība	Iepakojuma izmērs
160 / 190 / 254 / 305	1 vienība	Iepakojumā 1 gabals

MONTĀŽAS PIEDERUMI

Ventilācijas starta profils dēļiem skujiņā

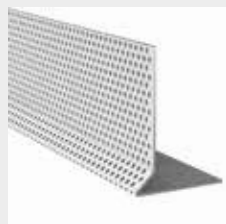

Startera un ventilācijas profila kombinācija. Pieejami trīs izmēri vispārīgiem rāmja izmēriem: 25 mm, 38 mm un 50 mm.

Izmērs rāmim mm	Garums mm	Vienības komplekts	Apm. svars par gabalu
25	3000	5	0,7
38	3000	5	0,7
50	3000	5	0,7

Ventilācijas profils dēlim un VL dēlim ar spundi



Ventilācijas profils ventilējamām fasādēm un aizsardzībai no grauzējiem. Pieejami trīs izmēri vispārīgiem rāmja izmēriem: 25 mm, 38 mm un 50 mm.

Izmērs rāmim mm	Garums mm	Vienības komplekts	Apm. svars par gabalu
25	3000	5	0,55
38	3000	5	0,65
50	3000	5	0,74

Gecko Gauge dēļu turētājs priekš HardiePlank



Pielāgošanas palīglīdzeklis HardiePlank® fasādes apšuvumiem, kas ļauj ērti samontēt dēļus un tādējādi uzstādīt tos vienpersoniski

Vienība	Iepakojuma izmērs
Komplekts	Komplektā 2gab.

Ērtai un ātrai montāžai piedāvājam bezmaksas dēļu turētāju Gecko Gauge.
Sazinies, lai noskaidrotu kā to saņemt!